

SO2R Box (plus)

Owner's Manual

Version 1.8

Yankee Clipper Contest Club

<http://so2r.k1xm.org/>

Legal Notices

Copyright © 2009, 2017 Paul Young. All Rights Reserved.

Windows, Windows NT, Windows XP, Windows Vista, Windows 7, Windows 8, Windows 8.1, and Windows 10 are registered trademarks of Microsoft Corporation.

Adobe is a registered trademark of Adobe Systems Inc.

Microchip is a registered trademark of Microchip Technology Inc.

Open Two Radio Switching Protocol (OTRSP) is copyrighted by Paul Young under a Creative Commons Attribution 3.0 License.

Other copyrights belong to their respective owners.

The Yankee Clipper Contest Club and Paul Young make no warranty of any kind with regard to this manual, hardware or software, including, but not limited to, the implied warranties of merchantability and fitness for a particular purpose. Paul Young shall not be held liable for errors contained herein or direct, indirect, special, incidental or consequential damages in connection with the furnishing, performance, or use of this material.

RESTRICTED RIGHTS: Use, duplication, or disclosure by the U.S. Government is subject to restrictions of FAR 52.227-19(6/87), FAR 12.212, and DFAR 252.227-7015.

Table of Contents

Introduction	1	Reset	24
Requirements	1	Version	24
Quick Start	2	Exit	24
Front and Rear Panels	4	RTTY	25
The Front Panel	4	MMTTY Setup	26
The Rear Panel	5	Updating the Firmware	29
SO2R Box Interface Program	9	Internal Jumpers	30
Keyer	10	Ground Jumpers	30
Headphones	12	Programming Jumper	31
Microphone	13	Troubleshooting	32
Radio Mapping	14	Features and Specifications	38
Serial Ports and Named Pipes	14	Power	38
Manual Control	16	Supported Radios	38
Displayed Information	16	Keyer	38
Version	17	PTT	39
Exit	18	Headphones	39
SO2R Box Utility Program	20	Microphone	40
Connect and Disconnect	21	Auxiliary	40
Keyer	21	RTTY	40
Headphones	22	USB	40
Microphone	22	SO2R Box Software Installation	41
Radio Mapping	22	FSK Installation	47
Auxiliary Outputs	22	RTTY Interface	48
RTTY	22	Interface	48
Send	23	OTRSP Extensions	50
Tune	23	Pipes	51
PTT	23		
Tests	23		
Displayed Information	24		
Update	24		

Introduction

...Then anyone who leaves behind him a written manual, and likewise anyone who receives it, in the belief that such writing will be clear and certain, must be exceedingly simple-minded. ... — Plato

This manual describes installation and use of the YCCC SO2R Box (plus). The box and software together provide a system for switching headphones, microphone, and keyer between two or more radios under control of a contest logging program and for sending International Morse Code on any connected radio.

Requirements

Hardware

The YCCC SO2R Box (plus) is required. It must be connected to a host computer through a USB cable for computer control, although the box can be used stand-alone as well.

Software

The SO2R Box software or equivalent is required to communicate with the hardware.

The supplied software is written for Microsoft Windows. Although the software may work with other versions of Windows, it is intended to work with Windows XP, Windows Vista, Windows 7, Windows 8, and Windows 8.1. Both 32- and 64-bit versions of Windows are supported.

A logging program is also required. Popular logging programs include:

N1MM Logger	http://www.n1mm.com/	V9.8.5 or later supports the SO2R Box.
Win-Test	http://www.win-test.com/	V4.4 or later supports the SO2R Box.
WriteLog	http://www.writelog.com/	V10.73 or later supports the SO2R Box.

A virtual COM port driver is also required to connect the SO2R Box interface program with the logging program (unless the logging program supports named pipes). Three free programs are available:

VSP Manager	http://k5fr.com/ddutilwiki/index.php?title=VSP_Manager
com0com	http://sourceforge.net/projects/com0com/files/
N8VB vCom	(Not currently available from the author)

Quick Start

Everything should be made as simple as possible, but not one bit simpler. — Albert Einstein

Most logging programs support serial ports. Some support Named pipes. Here is what you need to get up and running using serial ports:

1. Download the software setup file from <http://so2r.k1xm.org/>. Double-click the file to start installation. Accept the license and choose a directory for the SO2R Box software.
2. Connect the SO2R Box (plus) to a power supply, radios, and the computer. Turn the SO2R Box (plus) on. Set the transmit and receive switches to their center (Auto) positions.
3. Start the SO2R Box utility program. Click the “Connect” button. The program should be able to communicate with the SO2R Box (plus). Try changing CW speed, which radio is transmitting or receiving, etc. Exit the test program when you are done.
4. Select a virtual COM port driver If you do not know which one to use read the paper on the <http://so2r.k1xm.org/> downloads page. Install either VSP Manager or com0com. The VSP Manager driver is available for licensed amateurs only from Steve, K5FR. See http://k5fr.com/ddutilwiki/index.php?title=VSP_Manager for information about this driver. Information on installing and using com0com is available from the project website at <http://com0com.sourceforge.net/doc/UsingCom0com.pdf>.
5. Set up two pairs of virtual COM ports using the configuration utility that came with VSP Manager or com0com. Unless you your computer already has a COM4 or COM5, you could set up COM4 and COM14 as one pair and COM5 and COM15 as the second pair. This will work with WriteLog, N1MM Logger, and Win-Test.
6. Start up the SO2R Box interface program. It will immediately connect to the SO2R Box (plus). Set the Keyer and SO2R ports to one of each port pair. If you set them up as described in the previous step, set the keyer to COM14 and SO2R to COM15. Check the boxes to the left of the COM ports, and the program will connect to them.
7. Start your logging program. The SO2R Box interface program uses Open Two Radio Switching Protocol (OTRSP) commands for radio switching and Winkey commands for the keyer. If you are using the port numbers described above, set COM4 to Winkey and COM5 to OTRSP in your logging program.

8. You should now be able to control the SO2R Box (plus) from the logging program. It should send CW and should switch between transmit and receive.
9. Feel free to play with the SO2R Box (plus) and software. Other than feeding it excessive voltage, incorrectly using the internal Programming jumper, or running over it with a car, it will be pretty difficult to damage.

Some logging programs support named pipes. These are easier to use. Here is what you need to get up and running using pipes:

1. Download the software setup file from <http://so2r.k1xm.org/>. Double-click the file to start installation. Accept the license and choose a directory for the SO2R Box software.
2. Connect the SO2R Box (plus) to a power supply, radios, and the computer. Turn the SO2R Box (plus) on. Set the transmit and receive switches to their center (Auto) positions.
3. Start the SO2R Box utility program. Click the “Connect” button. The program should be able to communicate with the SO2R Box (plus). Try changing CW speed, which radio is transmitting or receiving, etc. Exit the test program when you are done.
4. Start up the SO2R Box interface program. It will immediately connect to the SO2R Box (plus). If the “Keyer” or “SO2R” boxes are checked, uncheck them. Check the box that is labeled “Pipes”.
5. Start your logging program. The SO2R Box interface program uses Open Two Radio Switching Protocol (OTRSP) commands for radio switching and Winkey commands for the keyer. Set the program to use OTRSP and Winkey pipes.
6. You should now be able to control the SO2R Box (plus) from the logging program. It should send CW and should switch between transmit and receive.
7. Feel free to play with the SO2R Box (plus) and software. Other than feeding it excessive voltage, incorrectly using the internal Programming jumper, or running over it with a car, it will be pretty difficult to damage.

Front and Rear Panels

Don't approach a goat from the front, a horse from the rear, or a fool from any side. — Yiddish Proverb

The Front Panel

The front panel has three switches and one rotary control.

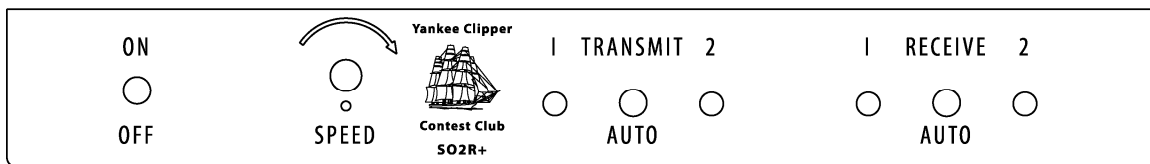

Only one transmitter can transmit at a time. The radio that can transmit has *transmit focus*. One receiver (or two if in stereo) can be heard through the headphones. The radios that can be heard have *receive focus*.

Control	Function
On / Off Switch	Turns the SO2R Box (plus) on or off.
Speed Control	Sets the keyer speed. This can be overridden by the computer.
Transmit Switch	Selects which radio has transmit focus. Auto allows the computer to select the transmit focus.
Receive Switch	Selects which radio has receive focus. Auto allows the computer to select the receive focus.

The lights around the transmitter and receiver switches indicate which radio is transmitting or receiving. Both receiver lights will illuminate when receiving in stereo.

The front panel controls can be used to control the SO2R Box (plus). The transmit and receive switches will override the computer selection. **If the transmit switch selection is different from the computer selection, sending from the paddle will work, but sending from the computer will be inhibited.**

The Rear Panel

The rear panel has eleven connectors.

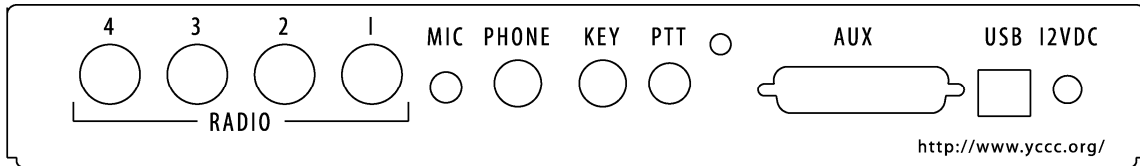

Connector	Type	Function
Radio 4	DIN 8	Audio, microphone, key, and PTT for Radio 4
Radio 3	DIN 8	Audio, microphone, key, and PTT for Radio 3
Radio 2	DIN 8	Audio, microphone, key, and PTT for Radio 2
Radio 1	DIN 8	Audio, microphone, key, and PTT for Radio 1
MIC	1/8" phone	Microphone, voice keyer, or sound card
PHONE	1/4" stereo phone	Stereo headphones
KEY	1/4" stereo phone	Single- or dual-lever paddle
PTT	RCA	Footswitch
	10-24 bolt	Chassis ground
AUX	DB25	Aux outputs, remote switching, remote status
USB	USB-B	USB interface to computer
12VDC	2.1mm	12 volts, center-positive

Radio Connector

Each radio is connected to the SO2R Box (plus) through a single connector. This connector typically has several cables connected to it.

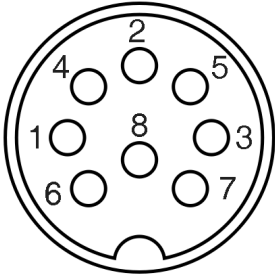

This view shows the connector pin numbering as seen looking at the back of the SO2R Box (plus). Note that the pins on a DIN connector are not numbered sequentially.

Pin	Purpose
1	Ground for PTT and CW key
2	Left (main) headphone audio
3	Right (secondary) headphone audio
4	PTT
5	Headphone audio common
6	CW key
7	Microphone ground
8	Microphone

Auxiliary Connector

The auxiliary connector provides the equivalent of two LPT ports and remote connections for the front panel switches and LEDs. Note that logging programs cannot take advantage of that many LPT pins yet.

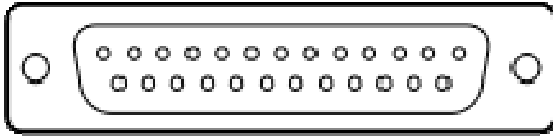

Pin	Purpose
1–8	Auxiliary outputs 1–8 (LPT-port-compatible voltage)
9	Ground
10	Ground to select Receiver 1
11	Ground to select Receiver 2
12	Ground to select Transmitter 1
13	Ground to select Transmitter 2
14	5V when Transmitter 2 is selected
15	5V when Receiver 1 is selected
16	5V when Receiver 2 is selected
17	+12V switched
18–25	Auxiliary outputs 9–16 (LPT-port-compatible voltage)

Although the auxiliary outputs have the same voltage levels as LPT port pins, the Auxiliary connector has many more outputs and is not compatible with an LPT port cable. Do not plug a cable that is wired for an LPT port into the Auxiliary connector, as you will probably damage something.

If RTTY FSK is enabled, Auxiliary connector pins 22, 23, 24, and 25 are FSK outputs for Radio 1, Radio 2, Radio 3, and Radio 4, respectively.

If TX on Aux 3 is enabled, pins 18, 19, 20, and 21 indicate transmitter selection of Radio 1, Radio 2, Radio 3, or Radio 4, respectively. The pin corresponding to the selected transmitter will be +5 volts, and the rest will be 0 volts.

See Chapter 5 for more information on TX on Aux 3. See Chapter 6 for information on RTTY.

SO2R Box Interface Program

Form ever follows function. — Louis H. Sullivan

The SO2R Box interface program communicates with both the SO2R Box (plus) and the logging software. It provides a dialog box. Each of its functions is explained below.

This program must be running when using a logging program with the SO2R Box (plus). It is OK to minimize it to save screen space. In normal contest operation you do not need to have this program's window displayed while it is running.

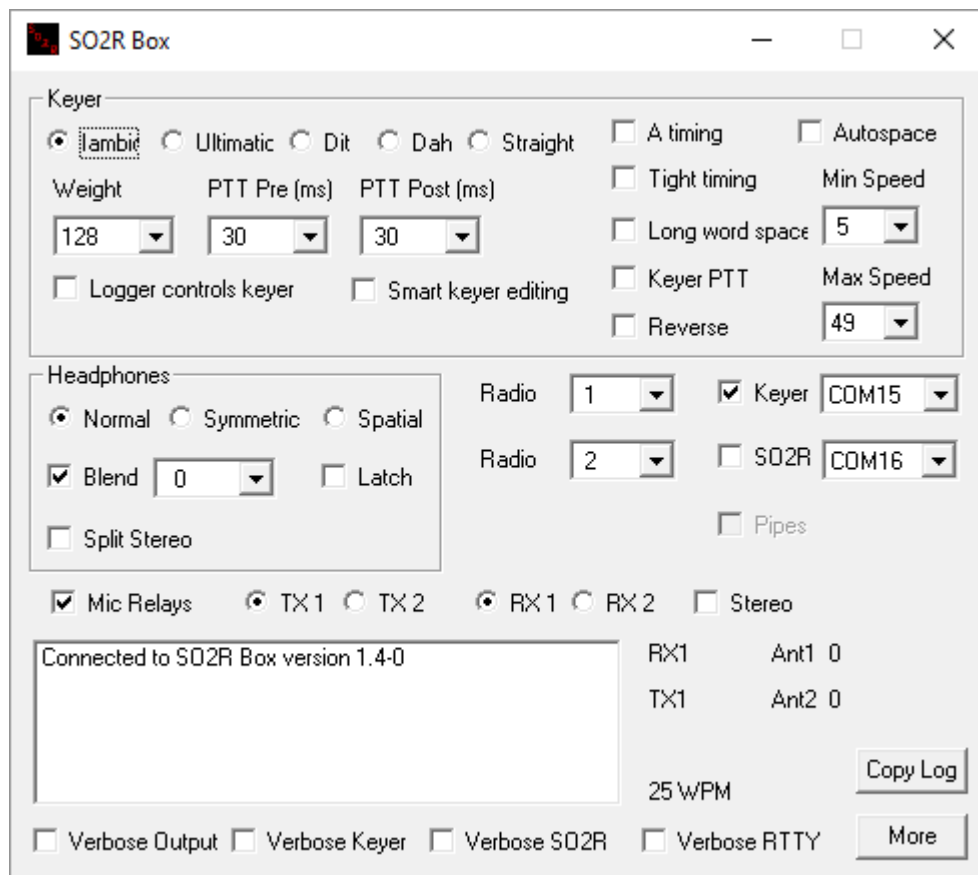

Keyer

The top panel (or “area”) of the dialog box contains the keyer controls. The keyer speed is always under control of the logging program.

Iambic, Ultimatic, Dit, Dah, Straight

These buttons select the keyer mode. They have no effect on characters sent from the computer.

In Iambic mode, if both paddles are pressed, the keyer will alternate between dits and dahs.

In Ultimatic mode, if both paddles are pressed, the keyer will send whichever was pressed last.

In Dit mode, if both paddles are pressed, the keyer will send dits.

In Dah mode, if both paddles are pressed, the keyer will send dahs.

In Straight (straight key) mode the keyer is inactive. The SO2R Box will send when the tip connection of the paddle is closed.

Weight

This menu sets the keying weight. Values are from 0 to 255. Higher values produce heavier weight (greater percentage of key down to key up). 128 corresponds to normal keying.

Min Speed and Max Speed

These menus control the range of keyer speeds that can be set with the front-panel speed control. The lowest minimum speed that can be selected is 2 WPM, and the highest maximum speed is 99 WPM.

If the difference between Min Speed and Max Speed is very large, it can be difficult or impossible for the front-panel speed control to select some intermediate keyer speeds.

PTT Pre and PTT Post

These menus set the time that the PTT line will close before characters are sent and the time after characters are sent until the PTT line will open. The values are in milliseconds, and the maximum value is 255. If the logging program tries to set a value greater than 255 milliseconds, the SO2R Box interface program will use 255 milliseconds.

PTT Pre is ignored when sending from a key in Straight mode. The key and PTT lines will be closed at the same time.

A timing

This box affects the paddle timing. If the box is checked, the keyer will use A timing; otherwise it will use B timing. (The names A and B timing originated with the WB4VVF Accu-Keyer.) B timing latches the paddle earlier than A timing. This setting affects only characters sent from the paddle.

Tight timing

At slower speeds the keyer will latch the paddle earlier, which can partially compensate for trying to send faster than the keyer speed. At high speeds it has no effect. This setting affects only characters sent from the paddle.

Reverse

This box changes which side of the paddle sends dits and which sends dahs. This setting affects only characters sent from the paddle.

Long word space

Normally, for characters sent from the computer, the keyer will wait six dit times between words. This is referred to as “contest spacing”. If Long word space is checked, the keyer will wait seven dit times between words (traditional spacing).

Keyer PTT

If Keyer PTT is checked, the PTT line will be closed before characters are sent from the paddle.

Logger controls keyer

If this box is checked, the logging program controls most of the keyer settings, such as mode, weight, and PTT pre and post. If it is not checked, the logging program cannot change these values. Either the logging program or the SO2R Box interface program dialog can set these values, but not both at the same time. Whether to have the logger control these settings is a personal preference.

Smart keyer editing

This box is a somewhat experimental feature that works only with some versions of N1MM Logger. Most logging programs allow you to edit a callsign while it is being sent. If a character that has already been sent is deleted, the keyer will repeat the letter it is sending. Checking Smart keyer editing suppresses the repeated letter.

For example, suppose you type the callsign AB1CDE and start sending it. While the computer is sending the 1, you delete the A. If Smart keyer editing is not turned on, the keyer will send AB11CDE. Deleting or changing characters that have not been sent works correctly whether or not Smart keyer editing is turned on.

Autospace

This affects only sending from the paddle. If this box is checked the keyer will force a full character space between characters.

Headphones

The headphone controls are below the keyer controls. They affect what you hear in each ear.

Radios that have a sub-receiver put the main receiver output in the left headphone and the sub-receiver in the right headphone when the sub-receiver is on. Otherwise the left and right headphone outputs are the same.

The logging program sends commands to select the receiver. It can select Radio 1 only, Radio 2 only, or stereo.

The SO2R Box (plus) has three headphones modes: Normal, Spatial, and Symmetric. The mode changes what is connected to each headphone in response to the receiver selection.

Normal

In Normal mode when one radio is selected, that radio is played through both sides of the headphones, as though the SO2R Box (plus) was not there. In Stereo the left (main) outputs of both radios are heard.

Logger Selects	Left Headphone Output	Right Headphone Output	Blend
Radio 1	Radio 1 Left (Main)	Radio 1 Right (Sub)	No
Radio 2	Radio 2 Left (Main)	Radio 2 Right (Sub)	No
Stereo	Radio 1 Left (Main)	Radio 2 Left (Main)	Yes

Spatial

In Spatial mode Radio 1 is always in the left headphone, and Radio 2 is always in the right headphone. Some people set up their SO2R stations with one radio on the left and one on the right, and having the left radio in the left ear and the right radio in the right ear allows them to use spatial perception to separate the radios' signals.

Logger Selects	Left Headphone Output	Right Headphone Output	Blend
Radio 1	Radio 1 Left (Main)	None	No
Radio 2	None	Radio 2 Left (Main)	No
Stereo	Radio 1 Left (Main)	Radio 2 Left (Main)	Yes

Symmetric

In Symmetric mode the left and right headphones are effectively connected together. This mode is useful for people who have a hearing loss in one ear and cannot effectively use stereo output.

Logger Selects	Left Headphone Output	Right Headphone Output	Blend
Radio 1	Radio 1 Left (Main)	Radio 1 Left (Main)	No
Radio 2	Radio 2 Left (Main)	Radio 2 Left (Main)	No
Stereo	Not available		

Blend

When blend is turned on, some of the audio from the left headphone is sent to the right headphone and vice versa. The Blend menu sets the amount. If the box is not checked, no audio is blended. Otherwise the amount depends on the Blend value — 0 allows a very small amount, and 255 is a complete blending of the channels.

Latch

In Latch mode, when the computer transmits, the headphones are automatically set to mono and moved to the radio that is not transmitting. When the transmission ends, the headphones will be returned to the radios they were connected to before the transmission started.

The headphones are not moved if the transmission is from the keyer paddle or microphone, even if the PTT switch is pressed.

Split Stereo

In split stereo mode whenever the transmit radio is not the same as the receive radio the headphones will switch to Stereo.

If Latch mode is also selected the headphones will switch to stereo whenever a radio is transmitting.

Microphone

Switching of the microphone is done with relays. The relays will be active if Mic Relays is checked. If you are using another method of microphone switching, such as a stereo sound card connected directly to the radios, or if you only operate CW and don't own a microphone, you can turn the relays off. This saves a teensy bit of electricity and stops the SO2R Box (plus) from making a clicking sound when switching transmitters.

Radio Mapping

Radio mapping is controlled by the Radio 1 and Radio 2 selection menus. Logging programs can deal with only two radios at a time. These menus tell the SO2R Box (plus) which two radios to use.

You can map any of the four radios to either Radio 1 or Radio 2. You can map the same radio to both Radio 1 and Radio 2. You can swap which radio is mapped to Radios 1 and 2, which could be very useful if you operate contests standing on your head.

Serial Ports and Named Pipes

Most logging programs can communicate with SO2R controllers through serial ports. They use two serial ports, one for the keyer to send CW and one to tell the SO2R box which transmitter and receiver to use.

Some programs communicate through Windows named pipes. They use two named pipes, one for the keyer and one for the SO2R radio control.

The SO2R Box (plus) hardware interfaces with the computer via a USB port. The SO2R Box interface program provides an interface between the hardware's USB interface and either the named pipes or a special kind of serial port, called a virtual COM port.

Virtual COM ports look like regular serial ports to programs. They have names like COM4, just like other serial ports. But they come in pairs, and anything that goes in one port of the pair comes out the other. The VSP Manager, com0com, and N8VB vCom drivers provide virtual COM ports.

Most logging programs know only about serial ports with low numbers. For example, in WriteLog the keyer port is COM1–COM8, and the SO2R port is COM1–COM16. In N1MM Logger the keyer and SO2R ports must be COM1–COM8. And in Win-Test they must be COM1–COM12.

The SO2R Box interface program can use ports COM1–COM32. Thus, you can assign one of the COM ports in each pair of virtual COM ports a low number so that the logging program can access it, and give the other a high number, often 10 or 20 higher.

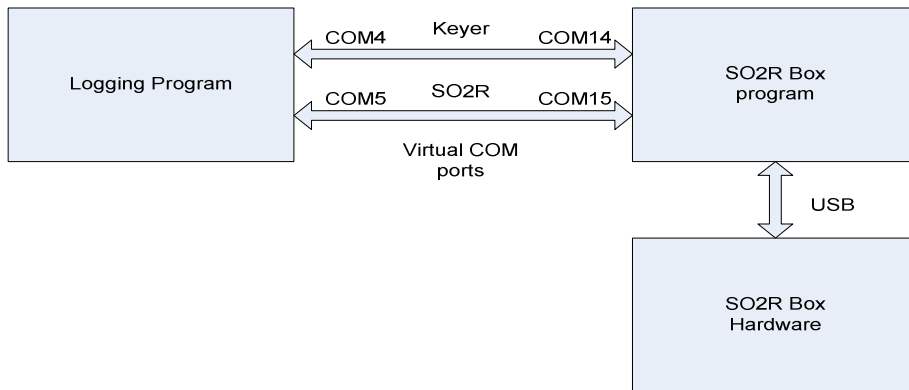

This diagram shows how everything communicates. The port numbers are set up in the configuration utility of VSP Manager, com0com, or vCom. The port numbers in the picture were chosen because they work with N1MM Logger, Win-Test, and WriteLog, but you can use any port numbers except the ones already assigned to other ports on your computer.

Named pipe communication is similar to virtual COM ports. Windows supports named pipes directly so it is not necessary to install any drivers. And the logging program knows the names of the pipes to use to communicate with the SO2R Box program so there is nothing to set up.

Keyer

If this box is checked the SO2R box program will receive keyer commands on the specified COM port.

SO2R

If this box is checked the SO2R box program will receive SO2R commands on the specified COM port.

Pipes

If this box is checked the keyer and SO2R communications will use named pipes.

Manual Control

It is possible to use the SO2R Box (plus) with a program that is not SO2R-aware but can control a WinKey keyer. For manual operation the box to the left of the SO2R Port must not be checked and the Pipes box must not be checked.

When the SO2R Port box or Pipes box is checked, the logging program will have control of the transmitter and receiver selection and these boxes will not appear.

Manual control works with phone and CW but does not change which radio will send FSK.

TX1

When this button is selected, the microphone, keyer, and PTT will be connected to Radio 1.

TX2

When this button is selected, the microphone, keyer, and PTT will be connected to Radio 2.

RX1

When this button is selected, the headphones will be connected to Radio 1.

RX2

When this button is selected, the headphones will be connected to Radio 2.

Stereo

When this box is checked, the headphones will be connected to both radios unless Symmetric mode is selected.

Displayed Information

The SO2R Box interface program has a box for text messages. Usually the only message you see is that the program has connected to the SO2R Box (plus). If problems arise, the program will display additional messages in this box. Below the text box are buttons that turn on more-verbose messages. If you turn on one or more of these, you will see lots of messages, mostly useful to software developers.

At the far right, near the bottom is the Copy Log button. Pressing this copies the contents of the box to the clipboard where it can be pasted into an e-mail message or a text editing program.

To the right of the text box are indicators that show the transmit radio and receive radio, the keyer speed, the values on some of the aux connector pins, and similar information.

If the front panel switches are used to set transmit or receive focus, the information displayed will include an asterisk (*). If the transmit setting disagrees with the computer setting, the word (Inhibit) will be displayed.

The Ant1 and Ant2 values are the values set on the Aux 1 and Aux 2 pins. The logging program may allow using these for antenna selection for Radio 1 and Radio 2, respectively. The possible values are from 0 to 15.

More

Pressing the button labeled More provides a dialog which has additional functions.

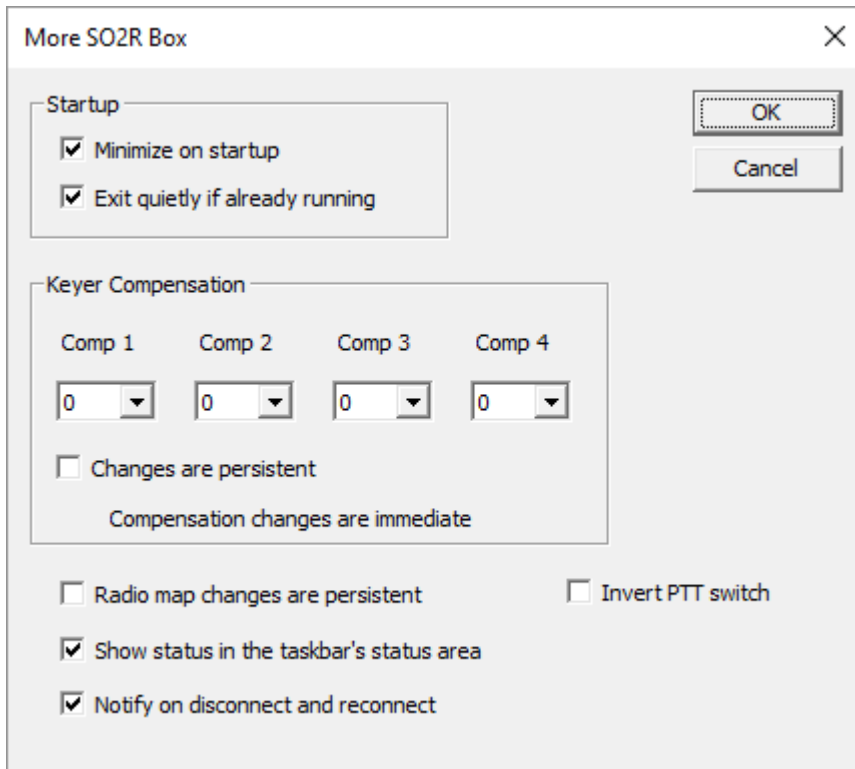

Minimize on startup

If this is set the SO2R Box program will minimize itself when it starts.

It will also minimize if it is started from a command line which includes /M.

Exit quietly if already running

When the SO2R Box program starts it will check if it is already running or if the SO2R Box Utility is running. If this is set it will exit quietly if it or the utility are already running. Otherwise it will display a dialog warning that another copy is running and will then exit.

It will also exit quietly if it is started from a command line which includes /Q.

Comp 1, Comp 2, Comp 3, Comp 4

Keyer compensation changes the length of all dits and dahs by a fixed amount. This is described in the SO2R Box Utility chapter.

Compensation changes take effect immediately. The OK and Cancel buttons have no effect.

Changes are persistent

If this is set keyer compensation changes will be stored in the SO2R Box and will be remembered when the power is turned off.

Radio map changes are persistent

If this is set the radio map changes on the SO2R Box dialog will be stored in the SO2R Box and will be remembered when the power is turned off.

Show status in the taskbar's status area

If this is set the program will add an icon to the taskbar's status area. If the SO2R Box is connected the icon will have two red and two green circles. The circles will show the same information as the LEDs on the SO2R Box. If the SO2R Box is disconnected the icon will show a circle with a slash.

The icon may be created in the overflow area. It can be dragged to the status area.

Notify on disconnect and reconnect

If this is set the program will put up a notification if the SO2R Box is disconnected from the application and when the SO2R box is reconnected.

Invert PTT switch

If this is set the sense of the PTT input will be inverted. The SO2R Box will key PTT when the PTT input is not shorted.

Version

You can display the version of the SO2R Box interface program from the system menu. Click the SO2R icon in the upper left of the program's title bar to see this menu. Select "About SO2R Box..." to display the version information. If the YCCC SO2R Box (plus) is connected, the firmware version will also be displayed.

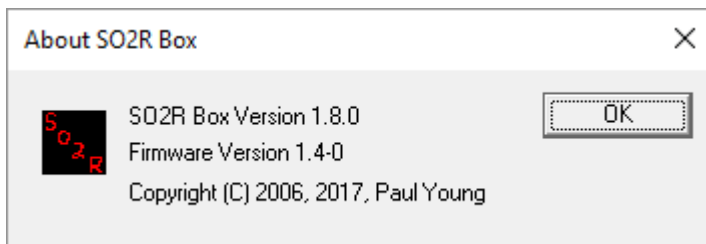

Exit

There are three ways to exit the SO2R Box interface program.

- Click on the “X” in the upper right corner of the title bar.
- Click on the icon in the upper left corner of the dialog box and select “Close”.
- Press ALT-F4.

SO2R Box Utility Program

The perfect computer has been developed. You just feed in your problems, and they never come out again. — Al Goodman

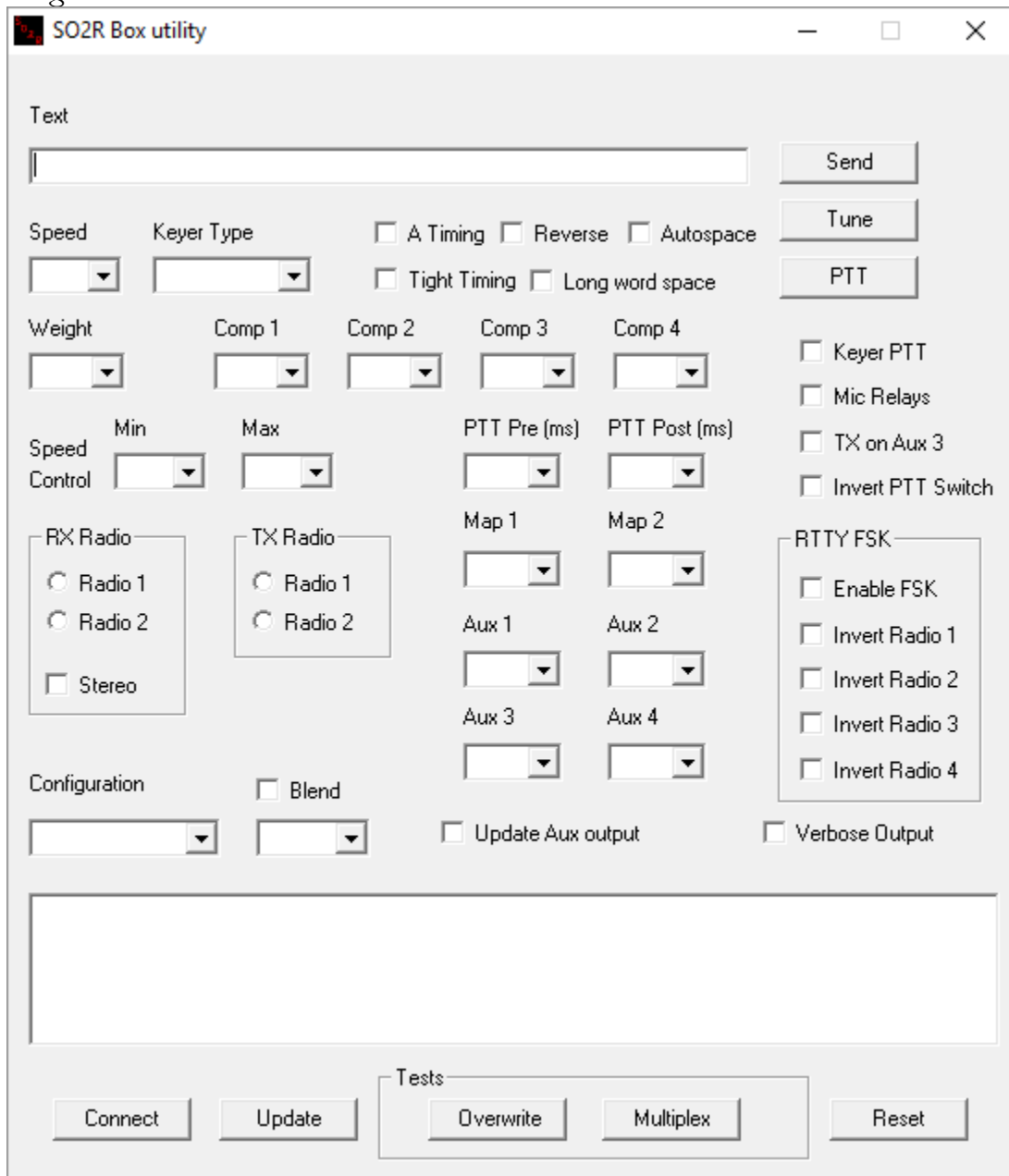

The SO2R Box utility program allows access to SO2R Box (plus) features without using a logging program. It can be used to test the box and also to load new firmware.

Connect and Disconnect

The lower left button is used to connect and disconnect the test program to or from the SO2R Box (plus). When the program is not connected, it will say “Connect”; and when the program is connected, it will say “Disconnect”.

You must connect to the SO2R Box (plus) to use any of the features of this program.

Keyer

The Keyer Type, Weight, PTT Pre, PTT Post, A Timing, Tight timing, Reverse, Autospace, Long word space, and Keyer PTT work the same as they do in the SO2R Box interface program, described in Chapter 4.

Speed

This menu sets the keyer speed. The speed range is 2 to 99 WPM. If the speed control on the front panel is changed, it will also change the speed setting shown by the test program.

Speed Control Min and Max

These menus control the range of keyer speeds that can be set with the front-panel speed control. The lowest minimum speed that can be selected is 2 WPM, and the highest maximum speed is 99 WPM.

The values set in the utility program are stored and will be used when the keyer is powered on.

If the difference between Min and Max is very large, it can be difficult or impossible for the front-panel speed control to select some intermediate keyer speeds.

Comp 1, Comp 2, Comp 3, Comp 4

Keyer compensation changes the length of all dits and dahs by a fixed amount. This can be used to compensate for a radio that clips dits and dahs in break-in mode or for a radio that does not stop a character when the keyer does.

The compensation can be set for each radio. The range of compensation is ± 63 milliseconds. The value will be stored and will be used when the keyer is powered on.

It is possible to set a compensation that is larger than the length of a dit or the space between two dits. If this is done, the keyer will not be able to send correctly. The maximum amount of compensation depends on the keyer speed.

Headphones

The headphones Configuration menu sets the mode, and the Blend menu sets the blend amount. They work the same as in the SO2R Box interface program.

Microphone

The Mic Relays checkbox works the same as it does in the SO2R Box interface program, described in Chapter 4.

Radio Mapping

The radio mapping works the same as it does for the SO2R Box interface program, with one important exception: Mappings set with the test program are remembered by the SO2R Box (plus). When you power up the SO2R Box (plus), it will use the last mapping set by the test program. Mapping changes from the SO2R Box interface program are not remembered.

Auxiliary Outputs

The Auxiliary connector has 16 LPT-port-compatible output pins. The SO2R Box utility program treats these as four groups of four pins each, called Aux 1, Aux 2, Aux 3, and Aux 4. You can set these to any value from 0 to 15. Most logging programs will output antenna or band information on Aux 1 and Aux 2.

If the Update Aux outputs box is checked, any changes to the Auxiliary outputs will appear immediately on the pins of the Auxiliary connector. If it is not checked, the SO2R Box (plus) will receive the changes but not change the outputs. This means that, if Update Aux outputs is not checked, you can change the values on all of the Aux boxes and then check the box, and all of the changes will appear on the Auxiliary connector pins at the same time.

TX on Aux 3

When the TX on Aux 3 box is checked, the Aux 3 output contains information on which radio has transmit focus. One of the four pins will be at +5 volts, corresponding to the selected radio. The other pins will be at 0 volts.

This value is stored and will be used when the keyer is powered on.

RTTY

When the Enable FSK box under RTTY FSK is checked, the Aux 4 output becomes a set of four RTTY FSK outputs, one for each radio. The value set in the Aux 4 box is ignored.

Normally the FSK output will be low on mark and high on space. Checking the Invert Radio 1, Invert Radio 2, Invert Radio 3, or Invert Radio 4 box will change the output for the specified radio to be high on mark and low on space.

The SO2R Box Utility cannot send RTTY. An application such as MMTTY must be used with the SO2R Box Interface Program in order to send RTTY.

Send

When the Send button is pressed, any text in the Text window will be sent. If you are not running a logging program, you can use this as a one-memory keyer.

Tune

Pressing Tune will key the selected transmitter. It will continue until the Tune button (now labeled “Stop Tune”) is pressed again, the paddle is touched, or 30 seconds has elapsed.

PTT

Pressing PTT keys the PTT line for the selected transmitter. It will remain keyed until the PTT button (now labeled “Stop PTT”) is pressed again.

Invert PTT Switch

When the Invert PTT switch box is checked the PTT input sense is inverted. The PTT line for the selected transmitter will be keyed except when the PTT input is shorted.

Tests

The SO2R Box (plus) has two tests.

Overwrite

For the Overwrite test the test program sends the SO2R Box (plus) keyer the first character in the Text window. Then it sends an “E”. Then it overwrites the “E” with another “E”. It continues to overwrite the “E” until it cannot because the keyer is sending it.

The number of overwrites depends on the keyer speed, the letter in the text box, and the USB speed. It tests a heavy communications load on the keyer.

Multiplex

The Multiplex test switches the receive focus between Radio 1 and Radio 2 10,000 times. This tests the audio switching circuitry under heavy load and also tests a heavy USB communications load.

Displayed Information

The SO2R Box utility program has an area for text messages. This box (bottom of window) will contain information such as whether the SO2R Box (plus) is connected, the firmware version, and results of tests.

Under the TX Radio box are indicators of the current front panel transmit and receive settings if they are not “Auto”.

Update

The Update button is used to install new firmware in the SO2R Box (plus). See Chapter 6 for more information on installing firmware.

If you press the Update button by accident, just turn the SO2R Box (plus) off, wait a second, and then turn it on. It will power up into normal operating mode.

Reset

The Reset button is used to reset the SO2R Box (plus) to the original defaults. This can be useful if the box is misbehaving – sometimes this is caused by the internal memory having a bad value.

When the keyer resets it disconnects from the utility. Press the Connect button to reconnect.

Version

You can find the version of the SO2R Box utility program from the system menu. Click the SO2R icon in the upper left of the dialog box to see this menu. Select “About SO2R Box utility...” to see the version information. If the YCCC SO2R Box (plus) is connected, the firmware version will also be shown.

Exit

There are three ways to exit the SO2R Box utility program.

- Click on the “X” in the upper right corner of the dialog box.
- Click on the icon in the upper right corner of the dialog box and select “Close”.
- Type ALT-F4.

RTTY

He is so old that his blood type was discontinued. —George William Curtis

FSK support currently works with MMTTY only. Several logging programs send FSK through MMTTY, and RTTY FSK will work with these programs. Currently these programs include N1MM Logger and Win-Test.

There are two known limitations. One is that MMTTY offers both 45 and 45.45 baud. If you select 45 baud, it will send at 45.45 baud. The other is that MMTTY offers 1, 1.5, and 2 stop bits. If you select 2 stop bits in MMTTY it will send 1.5 stop bits.

MMTTY Setup

MMTTY must use the EXTFSK DLL for transmit. Set this up as follows:

Start MMTTY. In the Option(O) menu choose Setup MMTTY(O)... When the dialog appears, choose the TX tab.

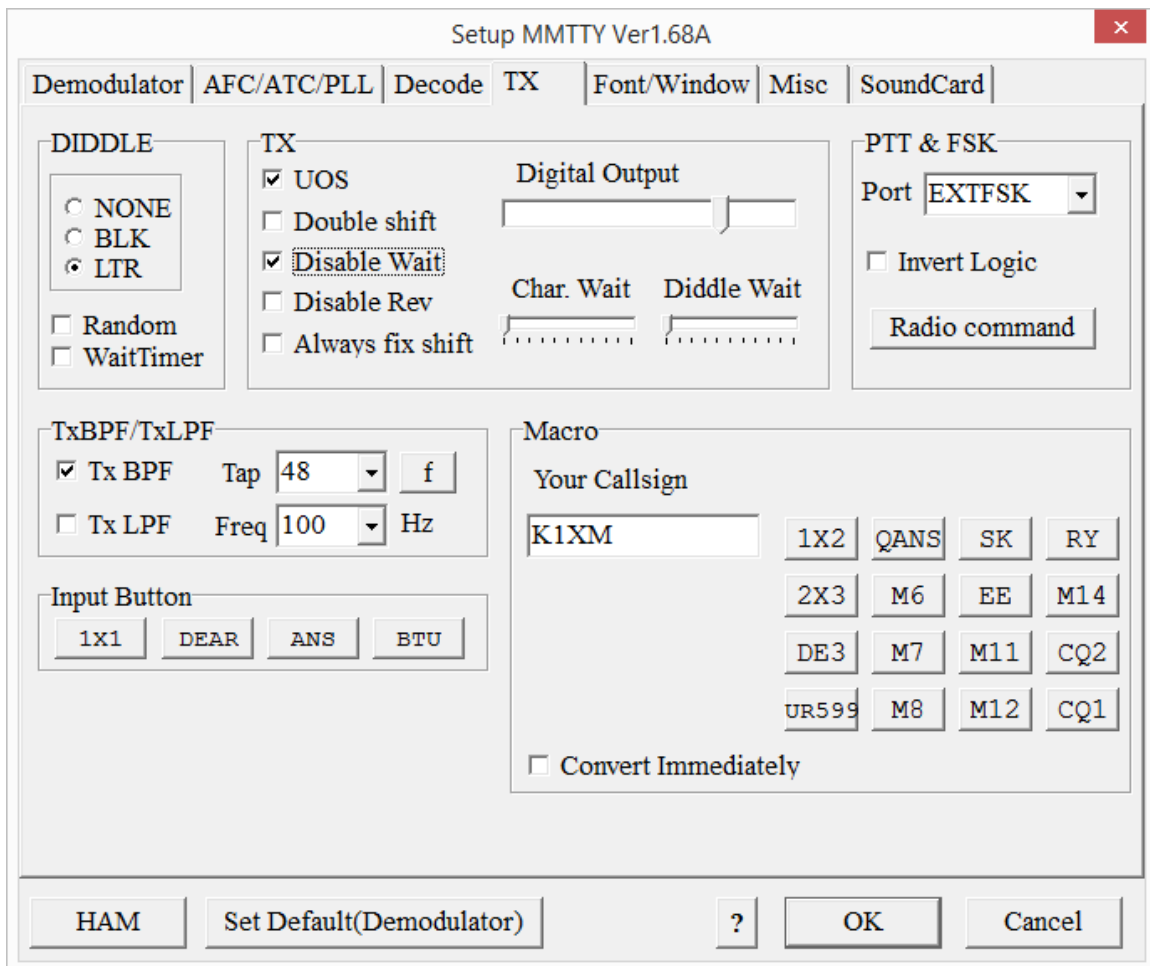

The right side of the dialog has a drop-down menu labeled PORT. Select EXTFSK. This item is at the bottom of the list, below all the COM ports.

Next, select the Misc tab. Under TX Port, select COM-TxD(FSK).

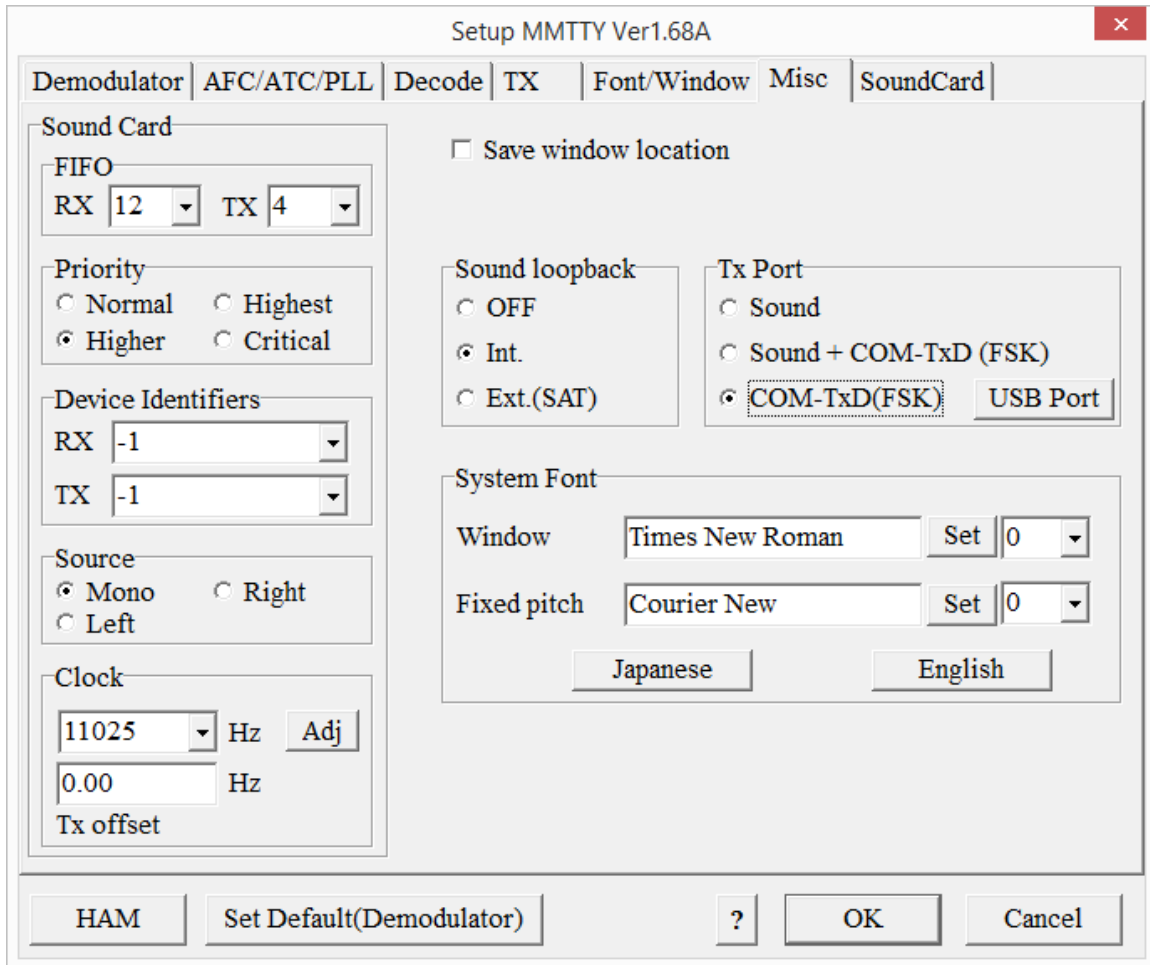

Click OK.

The large dialog box will disappear, and a small dialog box will appear.

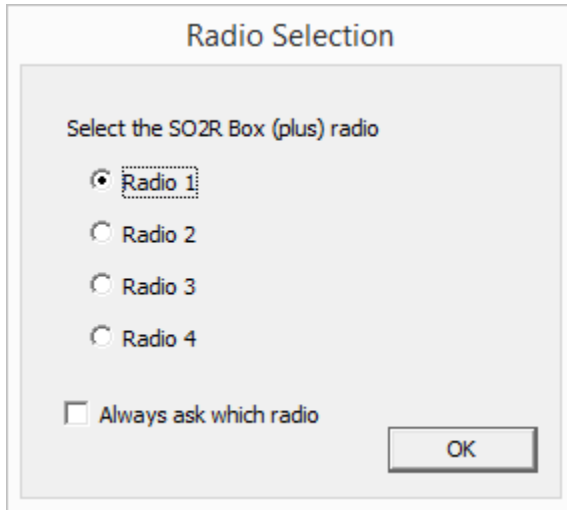

MMTTY is not SO2R-aware. You must tell the SO2R Box software which radio to use with MMTTY.

The radio selected is not affected by the SO2R Box (plus) radio map settings.

Logging programs that support SO2R use multiple copies of MMTTY, one for each radio. Set up each copy as described. The SO2R Box software will keep track of which MMTTY is for each radio, and you will not need to set it up again.

If you are using MMTTY with N1MM Logger or Win-Test, set up MMTTY stand-alone for each radio and then set it up in the logging program. Do not check the Always ask which radio box.

Updating the Firmware

New roads, new ruts – G. K. Chesterton

By installing new firmware you can add new features to the SO2R Box (plus), and fix bugs. Installation is a simple process.

1. Obtain the new firmware. Firmware updates will be posted at <http://so2r.k1xm.org/>.
The firmware file will have a .hex extension. Download it and save it to disk.
2. Put the SO2R Box (plus) in firmware update mode. This can be done in one of two ways:
 - a. If the SO2R Box (plus) is behaving normally, responding to commands from the test and interface programs, run the SO2R Box utility program. Click on Connect. When the program says it has connected, click on Update.
 - b. If the SO2R Box (plus) is not running normally, use the Programming Jumper described in Chapter 7.

When the SO2R box is in firmware update mode, both transmit LEDs will be lit and the receive LEDs will be blinking.

3. Upload the firmware. To do this, run the SO2R Box utility program if it is not already running. Click on Connect. When the program says it has connected in update mode, click on Update.

The SO2R Box utility program will display an Open File dialog. Open the .hex file you previously downloaded. The firmware will be installed in the SO2R Box (plus).

When the installation completes, the SO2R Box utility program will restart the SO2R Box (plus) and disconnect from it. The LEDs will stop blinking, and the SO2R Box (plus) will be ready for normal use.

Do not turn off or remove power from the SO2R Box (plus) or PC while updating the firmware. If you do, the SO2R Box (plus) firmware may be corrupted. In that case you will need to update it again, possibly using the Programming Jumper to put the SO2R Box (plus) into update mode.

Internal Jumpers

For every problem there is a solution which is simple, clean and wrong. — Henry Louis Mencken

The SO2R Box (plus) contains several jumpers. Most people will never need to use them.

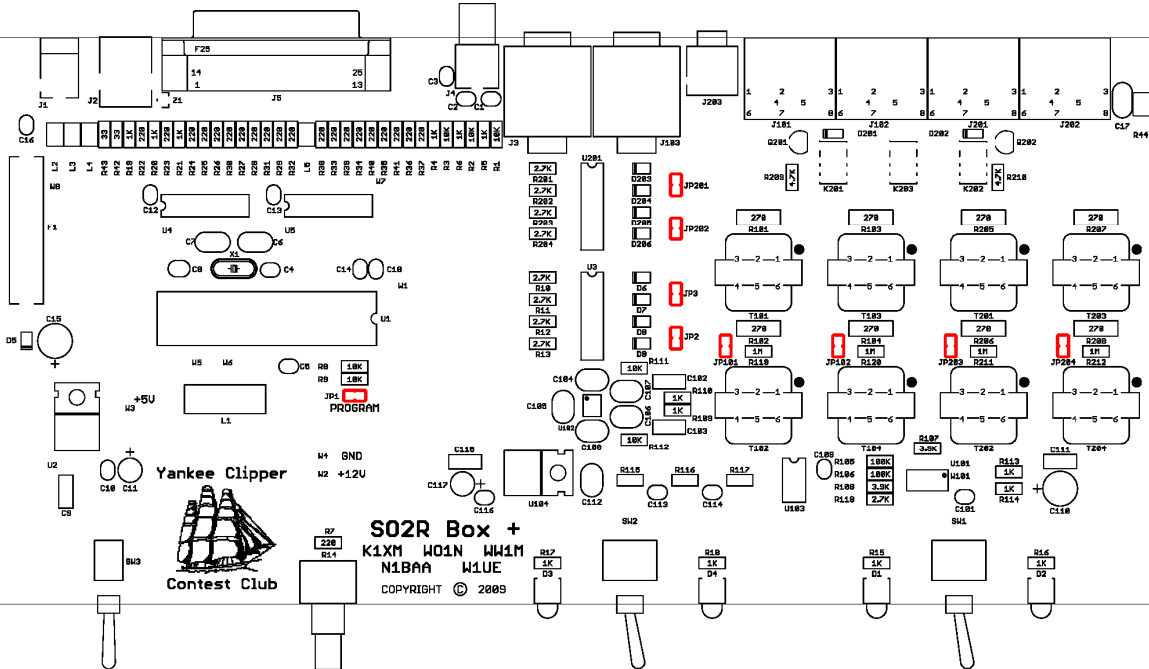

The locations of all jumpers are shown in red.

Ground Jumpers

By default, the keyer and PTT outputs, the microphone circuitry, and the headphone inputs are all isolated from ground. If this is not desirable, the following jumpers can be used to ground various circuits.

Jumper	Item grounded
JP2	Radio 1 key and PTT
JP3	Radio 2 key and PTT
JP101	Radio 1 headphones
JP102	Radio 2 headphones
JP201	Radio 4 key and PTT
JP202	Radio 3 key and PTT
JP203	Radio 3 headphones
JP204	Radio 4 headphones

Programming Jumper

Warning: Improper use of this jumper may damage the microprocessor! Do not connect the programming jumper while the SO2R Box (plus) is powered on. Remove the jumper before installing firmware.

Normally the microprocessor can be placed into firmware update mode by using the SO2R Box utility program. If this cannot be done because the firmware installed in the SO2R Box (plus) is corrupt, this procedure can be used to force the microprocessor into firmware update mode:

1. Turn the SO2R Box (plus) off and wait 30 seconds.
2. Short jumper JP1. This could be done by holding a screwdriver across the jumper pins or by installing a jumper across the pins. Make sure it is solidly shorted.
3. With the pins shorted, turn the SO2R Box (plus) on. It should immediately enter firmware update mode. Both transmit LEDs will be lit, and the receive LEDs will flash.
4. Remove the screwdriver or jumper before attempting to update the firmware.

Troubleshooting

Everything is funny as long as it is happening to somebody else. – Will Rogers

Note: The troubleshooting chapter is a work in progress.

SO2R Box (plus) does not appear to be on.

Check that it has power. Open the box and measure the voltage at the connector.

The SO2R Box has an internal fuse. Check that the fuse is good. You can check without removing the fuse by measuring the voltage on both sides of the fuse. It should be the same.

Check the internal +5 volt supply. The easiest way to do this is to measure the voltage from either lead of L1, which is the large inductor just below the 40-pin microprocessor.

Check for anything getting warm. If any part is more than slightly warm, turn off the SO2R box.

Try to place the SO2R Box (plus) in firmware update mode using the Programming Jumper as described in Chapter 7. If this is successful (the transmit LEDs light and the receive LEDs blink), install firmware as described in Chapter 6.

SO2R Box does not communicate with computer.

If you have never connected a USB keyboard or mouse or other HID (Human Interface Device) to your computer, try rebooting the computer after you connect and power on the SO2R Box (plus). Also, try to connect a USB mouse or keyboard and see whether it works properly. Keyboards and mice use the same driver as the SO2R Box (plus).

Use Device Manager to check whether Windows sees the SO2R Box (plus). To launch the Device Manager, right-click on My Computer (on the desktop or in the Start menu) and select Manage. Then select Device Manager. Click the + box next to Human Interface Devices to expand the list. You should see one or more devices, like this:

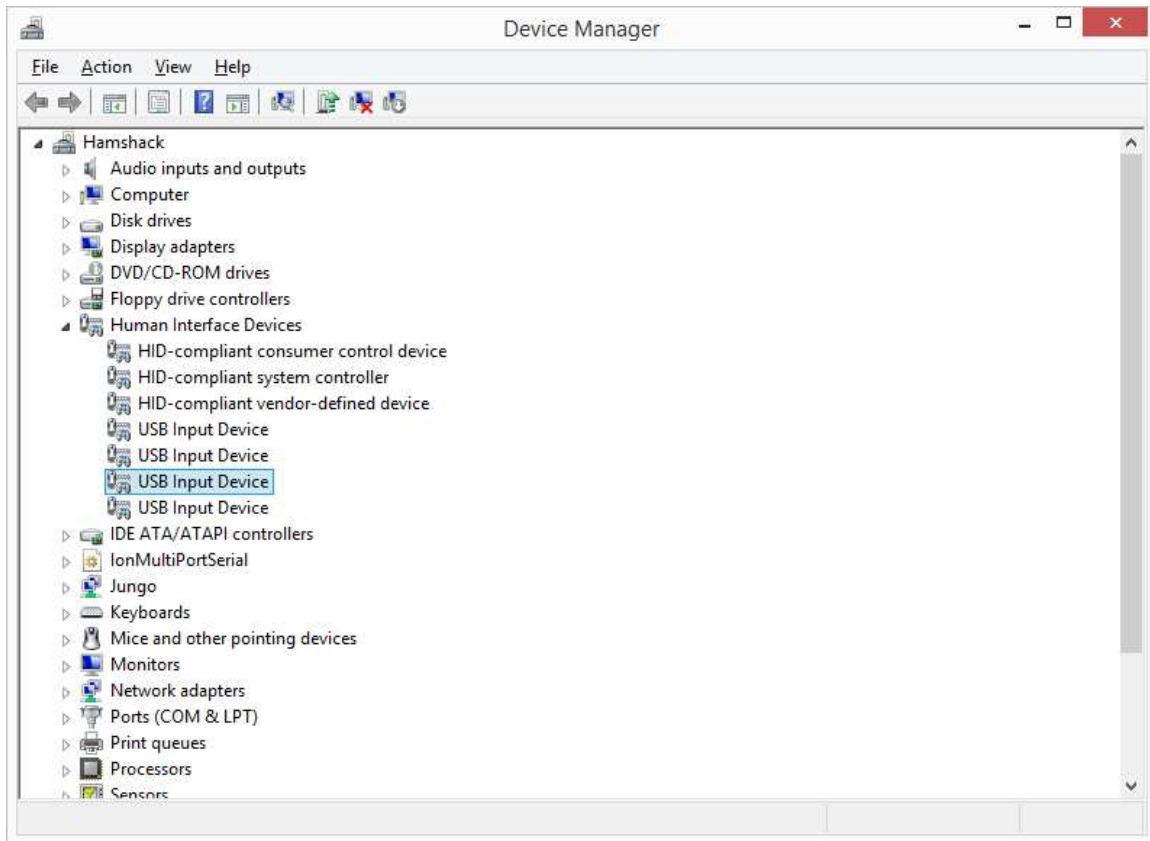

The SO2R Box (plus) is a USB Human Interface Device. Some versions of Windows will show it as an input device. Double-click on them one at a time until you find a box that says it is for the SO2R Box. The device properties window should look like this:

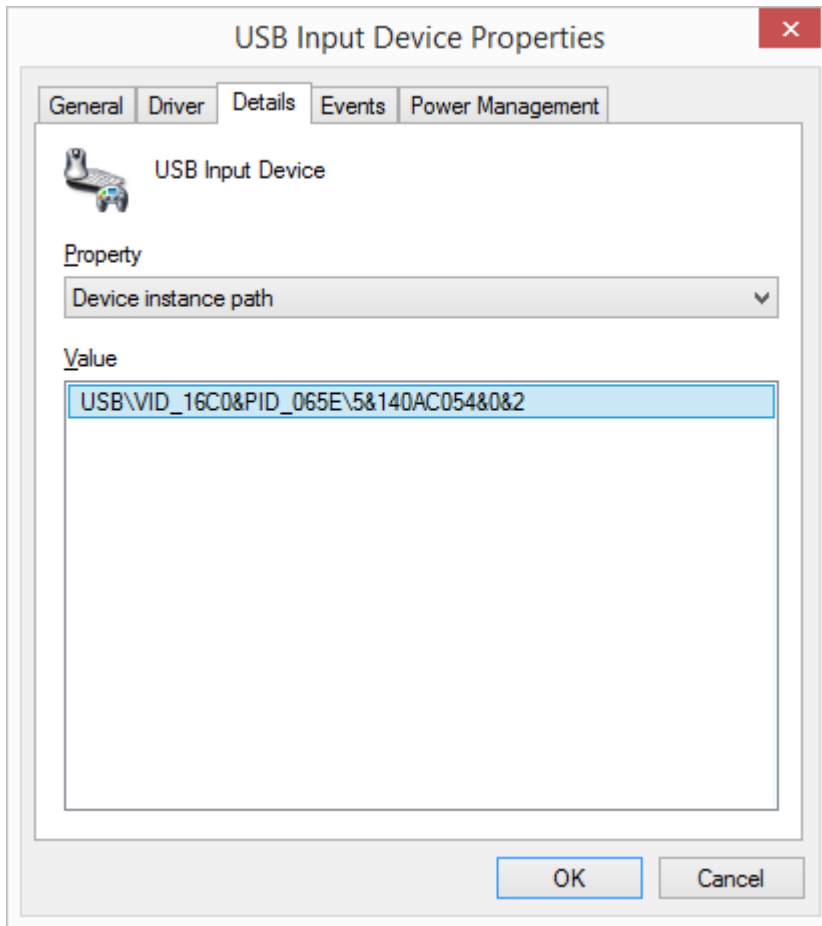

If you are able to find the SO2R Box (plus) HID device in Windows, then Windows has loaded the necessary drivers and is communicating with the SO2R Box (plus). Check the Details tab and select Device Instance ID in the menu. The information shown should start with USB\VID_16C0&PID_065E. If the numbers you see do not match these, the firmware is probably corrupt. Try to re-install the firmware using the Programming Jumper as described in Chapter 7.

If you are not able to find the device this way, Windows has not recognized it or loaded the drivers for it. Try using a different USB cable and a different USB port on the computer. If the SO2R Box (plus) is connected to a USB hub, try connecting it directly to the computer. As a last resort try connecting the SO2R Box (plus) to another computer. If all of these fail, the problem is likely internal to the SO2R box. Feel free to contact us for hardware troubleshooting assistance.

SO2R Box interface program does not communicate with logging program using virtual COM ports.

This problem can be caused by the SO2R Box interface program, the logging program, or the virtual COM ports being incorrectly configured.

If the SO2R Box interface program says that it cannot open the keyer port or the SO2R port because “The system cannot find the file specified”, it means that the COM port does not exist.

If you are using VSP Manager, run the VSP Manager configuration program (Start→All Programs→vspMgr→vspMgr) and verify that the ports are set correctly. Enable Strict Baudrate Emulation and Break Line/Restore Connection should *not* be checked.

If you are using com0com, run the Setup program (Start→All Programs→com0com→Setup) and verify that the ports are set correctly. It is not necessary to check any of the boxes such as “emulate baud rate”. Check that the ports are the ones you are using, and that the names are COM and not CNCA or CNCB.

If you are using N8VB vCom, run the VComConfiguration program (Start→All Programs→N8VBvCOM Driver→VComConfiguration) and verify that the ports are set correctly. Click Save Configuration. If this does not work, you may want to click Install Driver.

You may see messages about Windows finding new hardware or installing a driver. If you are prompted, click OK or Continue Anyway.

If the logging program is unable to connect to the COM ports, check that the logging program is connecting to the correct port, which is the other port in the pair and not the same port as the SO2R Box interface program is using.

If the logging program seems to connect but does not work correctly, verify that the Keyer port on the SO2R Box interface program is connected to the Winkey port in the logging program and that the SO2R port is connected to the OTRSP port in the logging program. If the keyer sends things like “X1” or “R2S” when you switch radios, then you probably have swapped the SO2R port and keyer port.

If you absolutely cannot get it to work, uninstall and reinstall the virtual COM port driver. Alternatively, try the other virtual COM port program (being sure first to uninstall the one you are currently using).

SO2R Box interface program does not communicate with logging program using named pipes.

This problem can be caused by the SO2R Box interface program or the logging program.

Make sure that the “Pipes” box is checked in the SO2R Box interface program and that OTRSP Pipes is selected in the logging program.

Check that only one logging program is running. The pipes cannot be used by more than one program at a time.

I get a headache when I try to do SO2R.

The obvious answer is “practice”, but here are suggestions to reduce frustration when operating SO2R:

- Turn down the receiver audio of both radios. With audio coming from two sources there is a natural tendency to keep turning up the volume level of the radio of interest. Your ears adjust and keep needing more volume as you go through the contest. Start with the volume as low as possible, and work on keeping it there.
- Turn down (or turn off) the monitor volume of the radio that is transmitting. There is no need to listen to this at anything but the lowest possible volume.
- Know the keystrokes that your logging program uses for the SO2R functions you will use. Read the SO2R section of the manual for your logging program, work a non-serious contest, figure out what you want to do but don't know how to, and then read the manual again.
- Practice SO2R in non-serious contests before you try to use it in a serious contest. RTTY is a good place to start.
- Don't try to heavily multitask. With one radio you listen, then call CQ, then listen. With two radios you will listen to Radio 1, then listen to Radio 2 while Radio 1 calls CQ, then listen to Radio 1. Do this for a while, and eventually it will become natural, and you will be able to spread your attention further.
- Turn down the RF gain. This can reduce garbage on the band and thus reduce fatigue.
- If you are going to CQ on two bands, make your CQ message the same length as your F2 message, and keep your F3 message short. This keeps things going and minimizes the time you keep the other station waiting. Count out the dits, dahs, and spaces of each message to try to equalize them.
- Know where your TX and RX focus are without having to look.
- Know when to use SO2R and when not. If the rate is high, you may not be able to use the second radio at all. If the rate is lower, you can try using the second radio for S&P. Lower still, you can try alternately calling CQ on two bands.
- Try Normal and Spatial modes and see which one works better for you. Also try some blending. For some people directional input is an important cue, and for others it is a distraction.
- If you find something that you want to do but the logging program requires two or three keystrokes to do it, use a free utility such as AutoHotKey to reassign one key to perform all of the keystrokes.

- Don't push too hard. If you can pick up four or five contacts per hour on the second radio, you will significantly increase your score in most contests.

Features and Specifications

Too much of a good thing can be wonderful. — Mae West

Power

Voltage	10 to 18VDC. Transient higher voltages, up to 30 volts, will not cause damage. Reverse-voltage and fuse protected.
Current	<70mA typical (no power drawn from aux connector)
Power connector	2.1mm circular, center-positive
Fuse	AGC ¼ amp

Supported Radios

Maximum radios	4
Radio connections	Keyer, PTT, Microphone audio, Headphone audio
Radio connector	8 pin DIN

Keyer

Speed	2–99 WPM (5–49 WPM from front-panel speed control)
Weight	0–100%, set as values 0–255
Paddle connector	¼" (7mm) stereo phone jack, dit paddle wired to tip, dah paddle wired to sleeve.
Modes	Iambic, Ultimatic, Dot preference, Dash preference
Maximum voltage	40V
Maximum current	10mA

Isolation	>10M Ω
Paddle voltage	5 Volts
Paddle current	0.5mA
Tuning	By computer command. Will stop on command, paddle press, or 30 second timer
Memorized	Keyer remembers last settings for mode, weight, A/B timing, tight timing, reverse, and long word spacing.

PTT

Maximum voltage	40V
Maximum current	10mA
Isolation	>10M Ω
Pre-send	0–255ms
Post-send	0–255ms
Controlled by	Computer, footswitch, keyer
Footswitch connector	RCA jack

Headphones

Modes	Normal, Spatial, Symmetric
Input impedance	Approx 270 Ω
Maximum voltage	10V P-P
Isolation	1 Meg to ground, transformer-isolated
Headphone connector	1/4" (7mm) stereo phone jack

Microphone

Switching	Relay switching, hot and ground
Isolation	>10M Ω
Microphone connector	1/8" (3.5mm) mono phone jack

Auxiliary

Aux Outputs	16 pins, "LPT-Port" voltage compatible
+12V switched	250mA max
Focus Outputs	5V if Transmitter 2, 5V if Receiver 1, 5V if Receiver 2
Inputs	Ground to force TX1, Ground to force TX2, Ground to force RX1, Ground to force RX2
Auxiliary connector	DB-25 female

RTTY

Speeds	22, 45.45, 50, 56, 75, 100, 110, 150, 200, 300 Baud
Bits	5, 6, 7, 8
Stop Bits	1, 1.5

USB

Connector	Full-sized USB-B
Compatibility	USB1.1 and USB2.0
USB power load	No power drawn from USB
Vendor ID	16C0 hex
Product ID	065E hex (operation), 065F hex (firmware update)

SO2R Box Software Installation

Nothing is so simple that it cannot be misunderstood. – Freeman Teague

The SO2R Box software consists of the SO2R Box interface program, the SO2R Box utility program, a copy of this manual, and an uninstall program.

The dialogs shown here are from a Windows XP system and might differ slightly from those under other versions of Windows such as Windows Vista or Windows 7.

Download the software from the download page at <http://so2r.k1xm.org/>. You may receive a security warning because you are downloading an executable file. If so, click the box that says it is OK. When the software has been downloaded, start it. You may receive an additional security warning that the publisher is unknown. If so, click the box that will run the software.

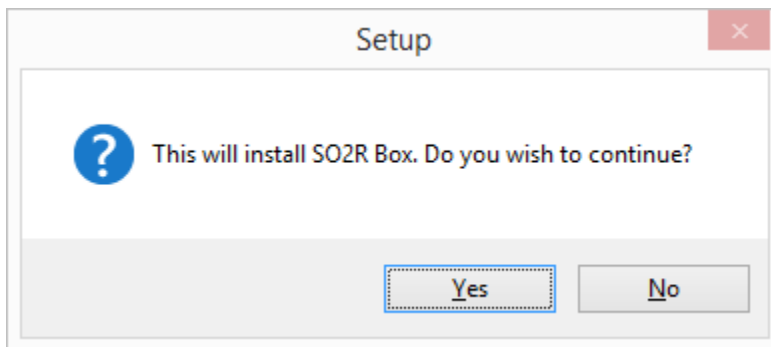

Click YES to continue.



The SO2R Box version number may be different for the software you install.

Click Next to continue.

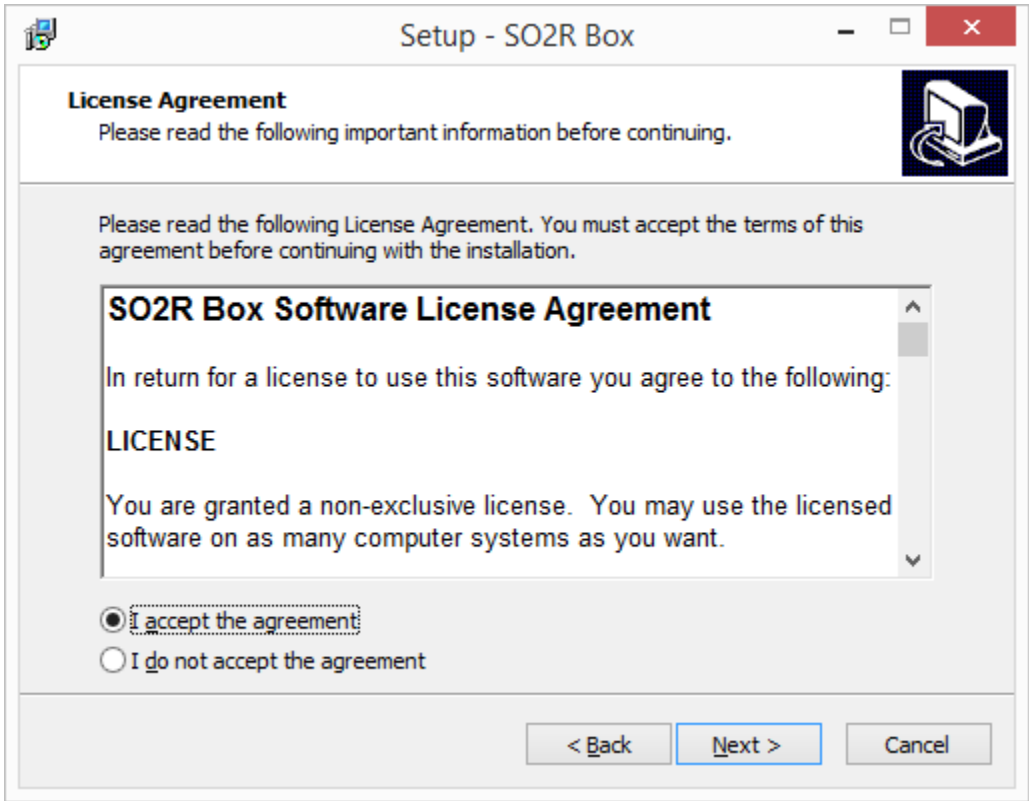

Read the license agreement, click that you agree, and then click Next.

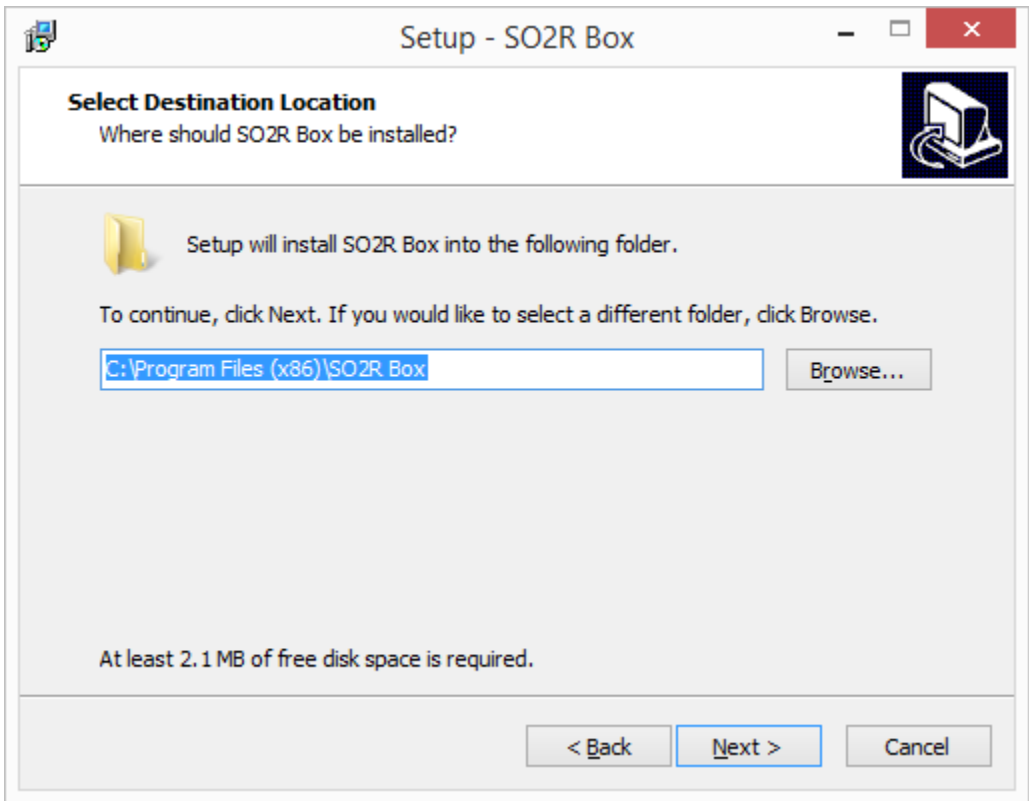

Normally the software will be stored in a directory called “SO2R Box”. Unless your system has a very unusual configuration, this will be where you want it. Click Next.

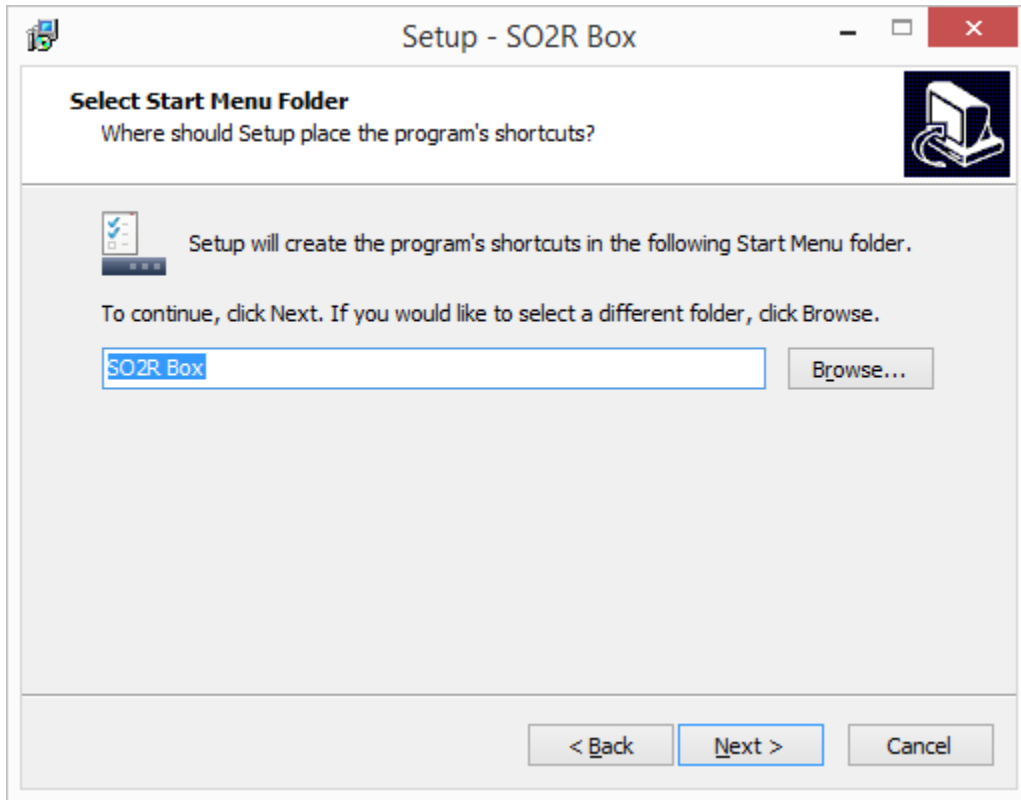

The default will create a folder in the Start Menu programs folder called SO2R Box. This is normally what you want. Click Next.

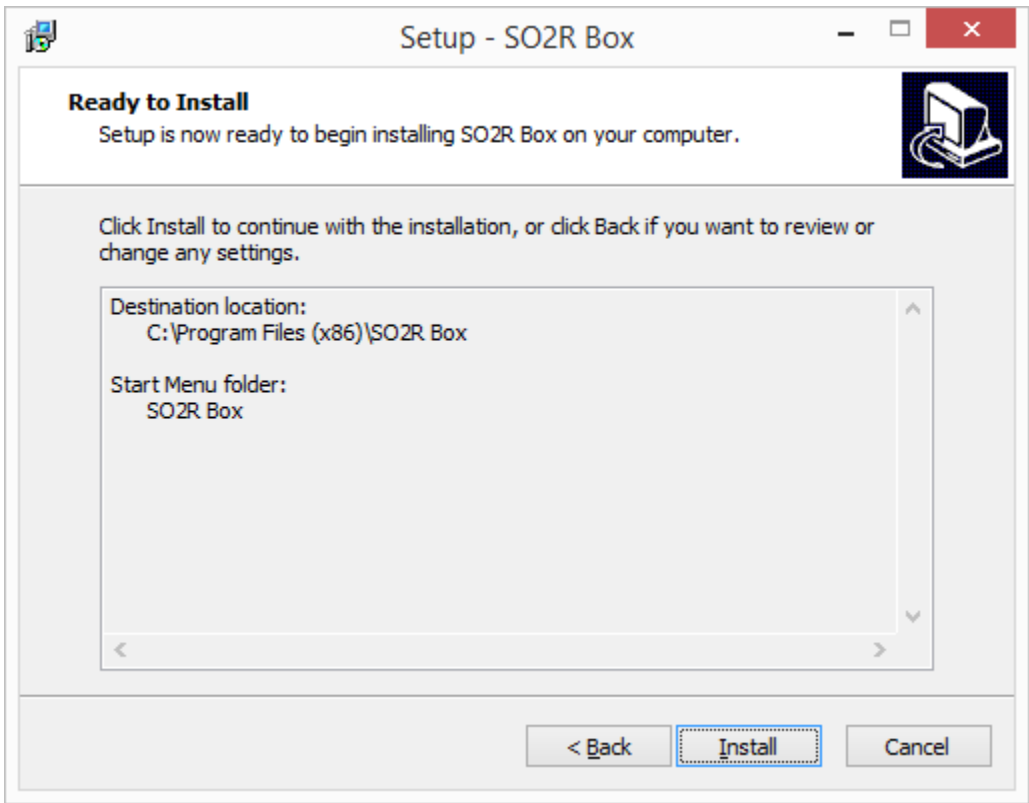

If the settings are acceptable, click Install.

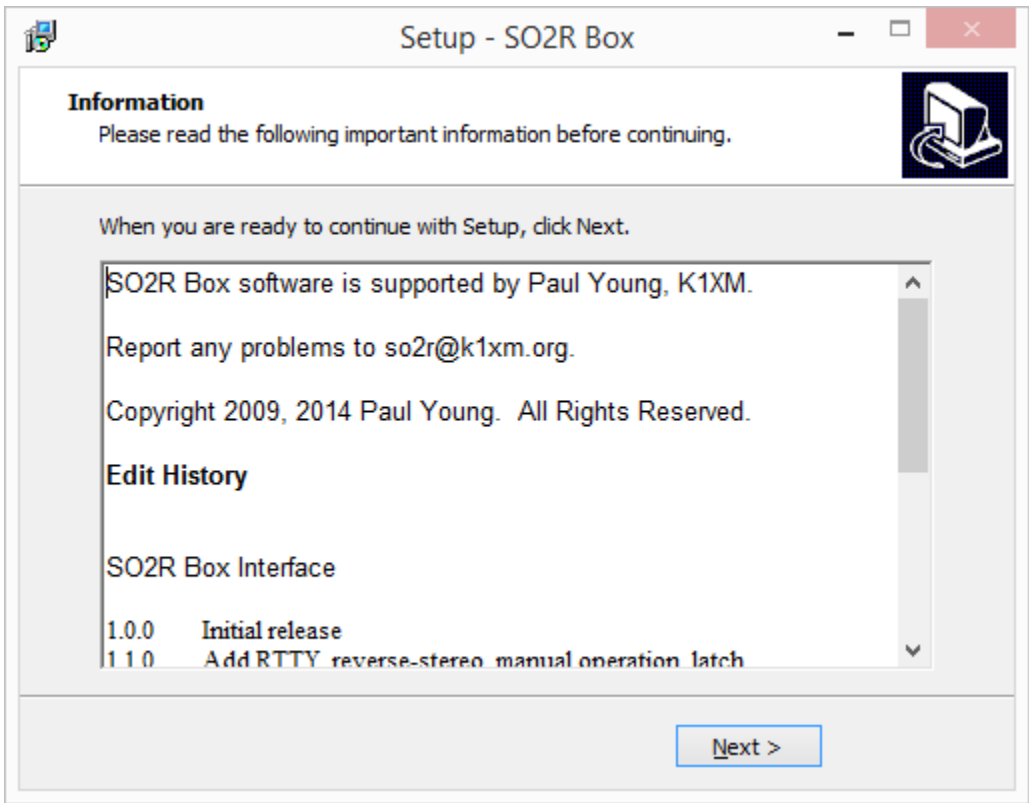

The installation usually takes only a few seconds. If it is successful, this box will appear. After reviewing the release information, click Next.



Click Finish.

You can start the software from the Start menu. Unless you changed the name in the installation dialog, the programs will be in the Start→All Programs→SO2R Box.

The SO2R Box interface program is called “SO2R Box”, and the SO2R Box utility program is called “SO2R Box Utility”.

The uninstall program will remove the SO2R box software. It does not remove the configuration file used by the SO2R Box interface program. This is convenient because you can uninstall one version of the software and install a different version without having to configure it. If you want to delete the configuration, it is in the file “SO2RBox.ini”. On Windows XP and older systems the INI file is normally found in C:\Documents and Settings\All Users\Application Data\SO2R Box, and on Windows Vista and newer systems it is normally found in C:\ProgramData\SO2R Box. These folders may be hidden. If you cannot see a folder in Windows, select Folder Options in the Tools menu, select the View tab, and check “Show hidden files and folders”.

FSK Installation

In order to send FSK with the SO2R Box (plus), you must install the EXTFSK DLL.

The DLL is available from the same download page. It is in a ZIP file. Unzip it and copy EXTFSK.DLL into the directory where the MMTTY program is installed. If you have more than one copy of MMTTY installed, copy EXTFSK.DLL into each directory where MMTTY is

RTTY Interface

Anyone who thinks hard work will never hurt you has never had to pay to have it done. — Thomas Kempis

The YCCC SO2R Box (plus) sends RTTY FSK using four pins on the AUX port. The pins are as follows:

Pin	Function when FSK enabled	Function when FSK disabled
22	Radio 1 FSK output	Aux 4 bit 0
23	Radio 2 FSK output	Aux 4 bit 1
24	Radio 3 FSK output	Aux 4 bit 2
25	Radio 4 FSK output	Aux 4 bit 3
9	Ground	Ground

Interface

The FSK outputs provide 0/+5 volts. An interface is needed to connect the outputs to most radios. A simple interface can consist of a single transistor and resistor for each radio:

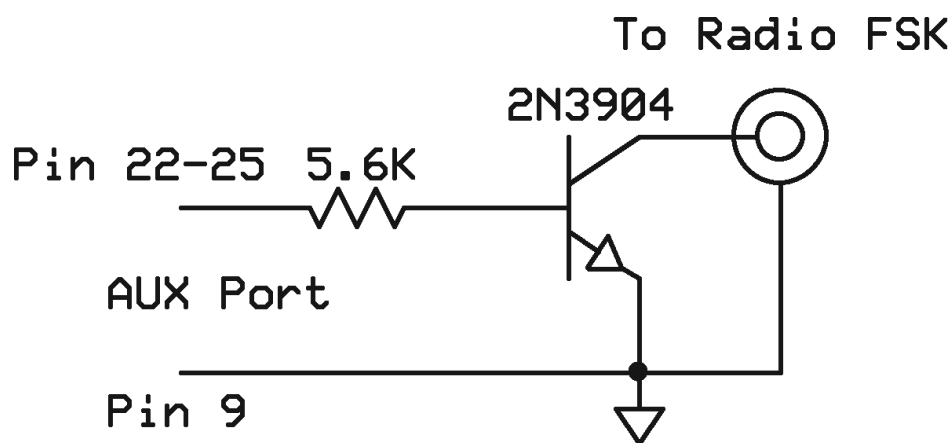

The disadvantage of a single-transistor interface is that the grounds of both radios are connected to pin 9 of the AUX connector and to the SO2R Box ground. This could cause a ground loop.

An alternative is to use an optoisolator. The diagram below shows a circuit for four radios. A PS2502-2 optoisolator could be used for a two-radio circuit.

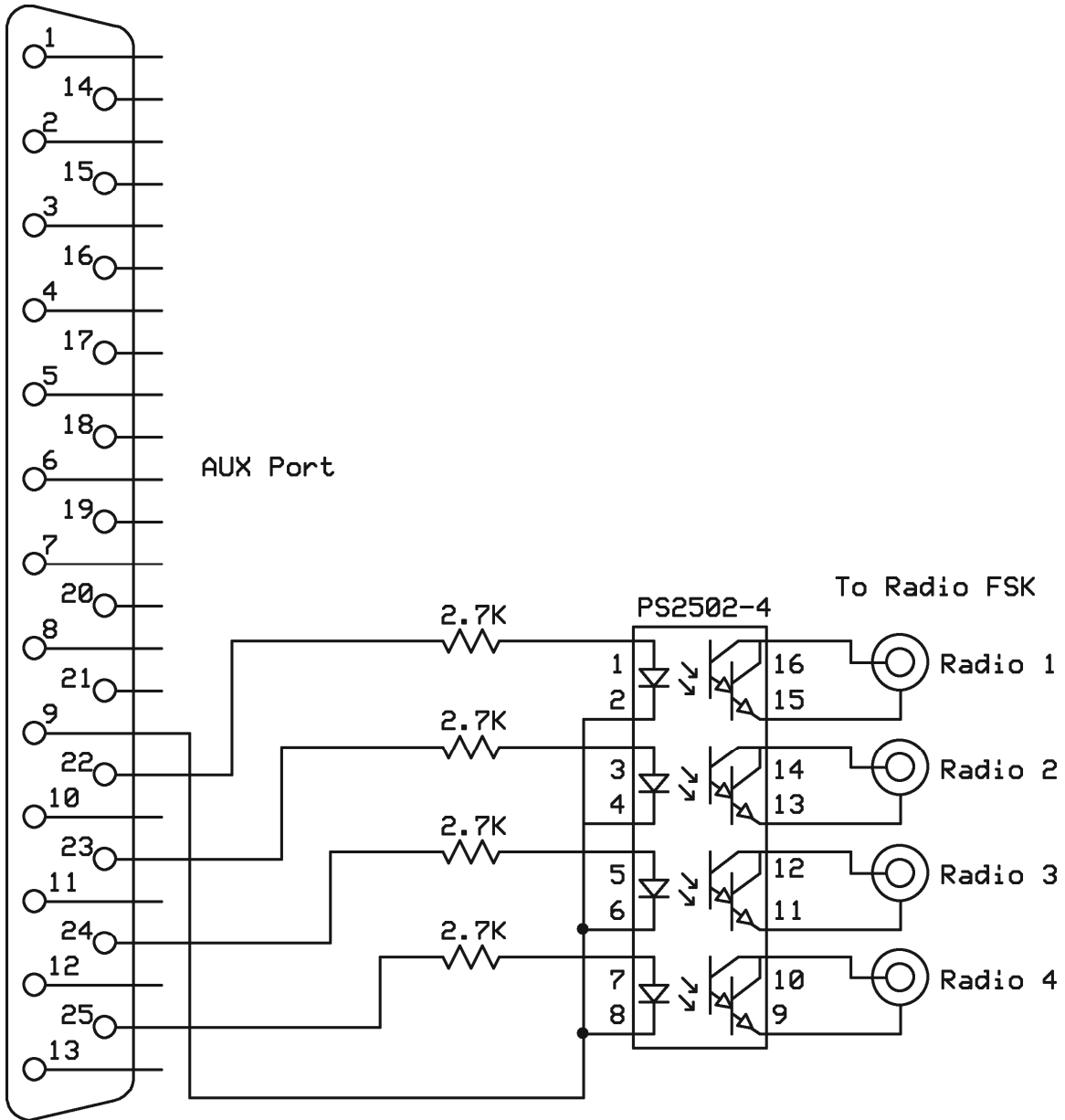

OTRSP Extensions

I do not fear computers. I fear the lack of them—Isaac Asimov

The YCCC SO2R Box (plus) supports several vendor-specific commands. These commands allow logging programs to control SO2R Box features which can otherwise be accessed through the SO2R Box program.

VLATCH

This command turns the latch mode on and off. It is equivalent to the Latch checkbox in the Headphones area of the SO2R Box Interface program. VLATCH1 turns the latch feature on. VLATCH0 turns the latch feature off. VLATCHT toggles the feature, turning it on if it was off and vice-versa.

VPHONE

This command sets the headphone mode. It is equivalent to the Normal, Symmetric, and Spatial buttons in the Headphones area of the SO2R Box Interface program. VPHONE0 sets the headphones to Normal mode. VPHONE1 sets the headphones to Spatial mode. VPHONES2 sets the headphones to Symmetric mode.

VBLEND

This command turns on the headphones blending. It is equivalent to the Blend checkbox in the Headphones area of the SO2R Box Interface program. VBLEND1 turns on blending. VBLEND0 turns off blending.

VBVAL

This command sets the amount of headphones blending. It is equivalent to the menu in the Headphones area of the SO2R Box Interface program. Values from 0 – 255 are allowed. VBVAL0 produces very little blending. VBVAL255 produces almost complete blending.

VSPLITSTEREO

This command turns the split stereo mode on and off. It is equivalent to the split stereo checkbox in the Headphones area of the So2R Box Interface program. VSPLITSTEREO1 turns the split stereo feature on and VSPLITSTEREO0 turns the split stereo feature off. VSPLITSTEREOT toggles the feature, turning it on if it was off and vice-versa.

Pipes

Be silent, or say something better than silence – Pythagoras

The SO2R Box named pipes interface has the following parameters:

- There are two pipes. The pipe for the OTRSP interface is [\\.\PIPE\OTRSP_DEVICE](#). The pipe for the keyer is [\\.\PIPE\WINKEY_DEVICE](#).
- The pipes are created in message mode. Commands do not need to start or end on message boundaries. The maximum message that the interface can handle is 4096 characters. It always sends one-character messages.
- The OTRSP implementation uses the X1/X0 commands to turn PTT on and off. These commands are only supported through the pipe interface, not through the serial port interface.